

TRANSFER DRIVEN GEAR

MANUAL TRANSMISSION AND DIFFERENTIAL

11. Transfer Driven Gear

A: REMOVAL

- 1) Remove the manual transmission assembly from vehicle. <Ref. to 5MT-26, REMOVAL, Manual Transmission Assembly.>
- 2) Remove the back-up light switch and neutral position switch. <Ref. to 5MT-35, REMOVAL, Switches and Harness.>
- 3) Remove the transfer case with extension case assembly. <Ref. to 5MT-39, REMOVAL, Transfer Case and Extension Case Assembly.>
- 4) Remove the extension case assembly.
- 5) Remove the transfer driven gear.

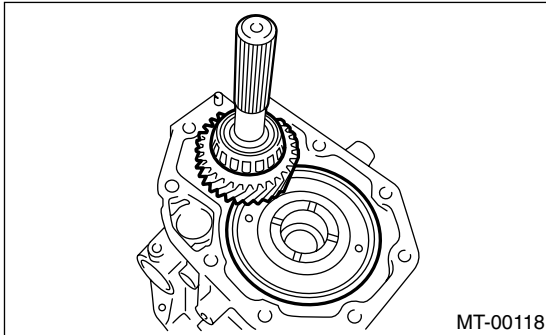

- 6) Remove the bearing outer race from extension case and transfer case.

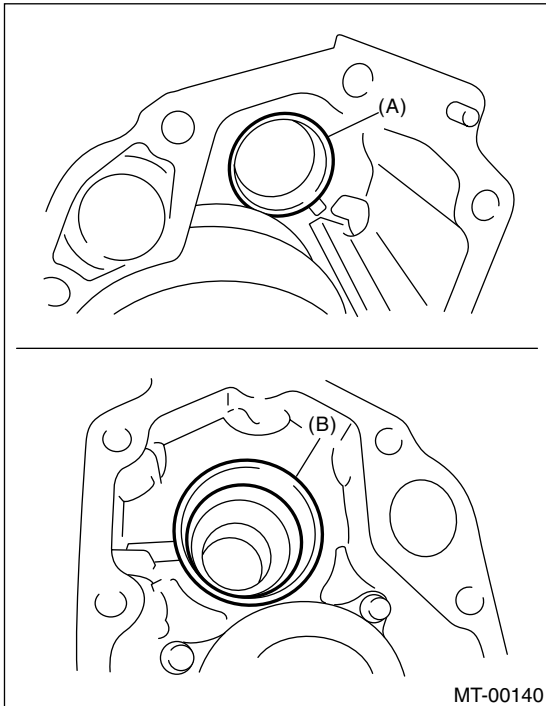

- (A) Bearing outer race (transfer case)
- (B) Bearing outer race (extension case)

B: INSTALLATION

- 1) Install the bearing outer race to extension case and transfer case.

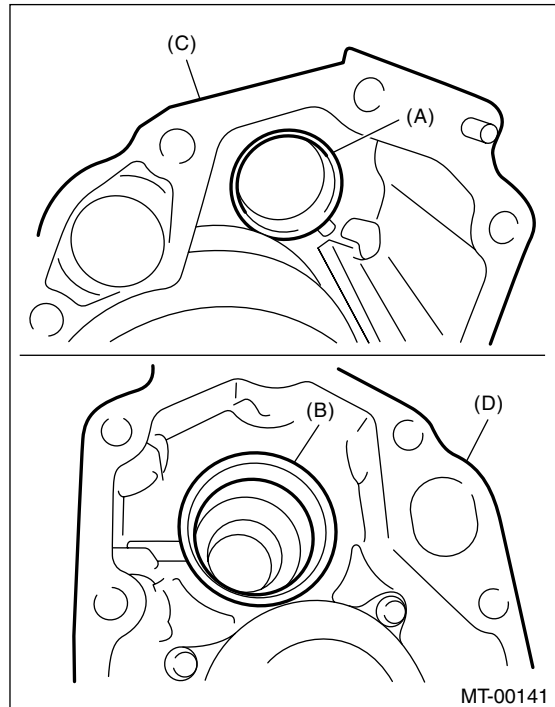

- (A) Bearing outer race
- (B) Bearing outer race
- (C) Transfer case
- (D) Extension case

- 2) Install the transfer driven gear.

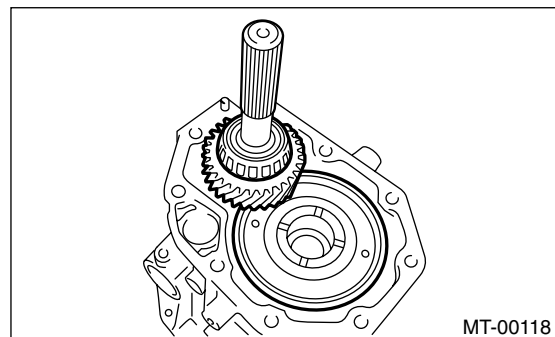

- 3) Install the transfer case and extension case assembly. <Ref. to 5MT-39, INSTALLATION, Transfer Case and Extension Case Assembly.>
- 4) Install the back-up light switch and neutral position switch. <Ref. to 5MT-35, INSTALLATION, Switches and Harness.>
- 5) Install the manual transmission assembly to vehicle. <Ref. to 5MT-29, INSTALLATION, Manual Transmission Assembly.>

TRANSFER DRIVEN GEAR

MANUAL TRANSMISSION AND DIFFERENTIAL

C: DISASSEMBLY

1) Using the ST, remove the roller bearing (extension case side).

ST 498077000 REMOVER

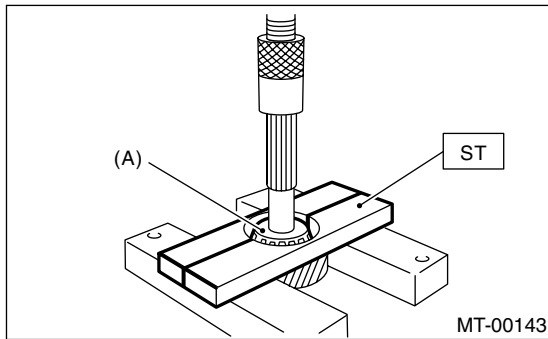

(A) Roller bearing

2) Using the ST1 and ST2, remove the roller bearing (transfer case side).

ST1 498077000 REMOVER

ST2 899864100 REMOVER

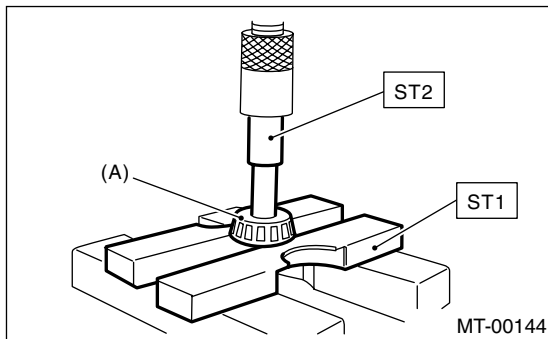

(A) Roller bearing

D: ASSEMBLY

1) Using the ST, install the roller bearing (extension case side).

ST1 398177700 INSTALLER

ST2 899864100 REMOVER

NOTE:

Do not apply pressure in excess of 10 kN (1 ton, 1.1 US ton, 1.0 Imp ton)

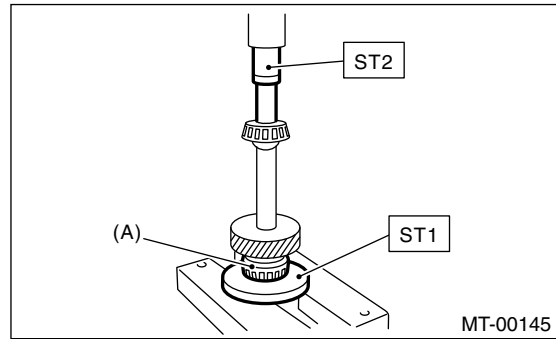

(A) Roller bearing

2) Using the ST, install the roller bearing (transfer case side).

ST 499757002 INSTALLER

NOTE:

Do not apply pressure in excess of 10 kN (1 ton, 1.1 US ton, 1.0 Imp ton)

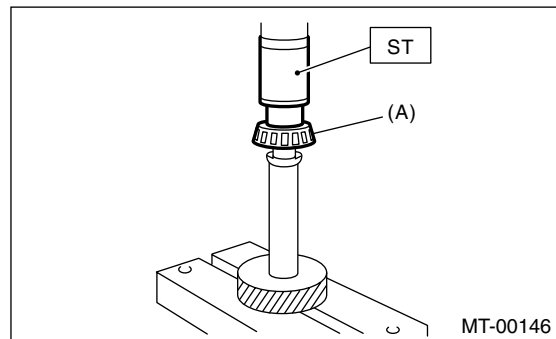

(A) Roller bearing

E: INSPECTION

1) Bearings

Replace the bearings in the following cases:

- Broken or rusty bearings
- Worn or damaged
- Bearings that fail to turn smoothly or make abnormal noise when turned after gear oil lubrication.

2) Driven gear

Replace the drive gear in the following cases:

- If their tooth surfaces and shaft are excessively broken or damaged.